

# ASSEMBLY AND INSTALLATION INSTRUCTIONS

P0180

**WARNING:** TO AVOID RISK OF ELECTRICAL SHOCK, BE SURE TO SHUT OFF POWER BEFORE INSTALLING OR SERVICING THIS FIXTURE.

**NOTES:** 1. Before installing, consult local electrical codes for wiring and grounding requirements.  
2. READ AND SAVE THESE INSTRUCTIONS.

## Hardware Package (included):

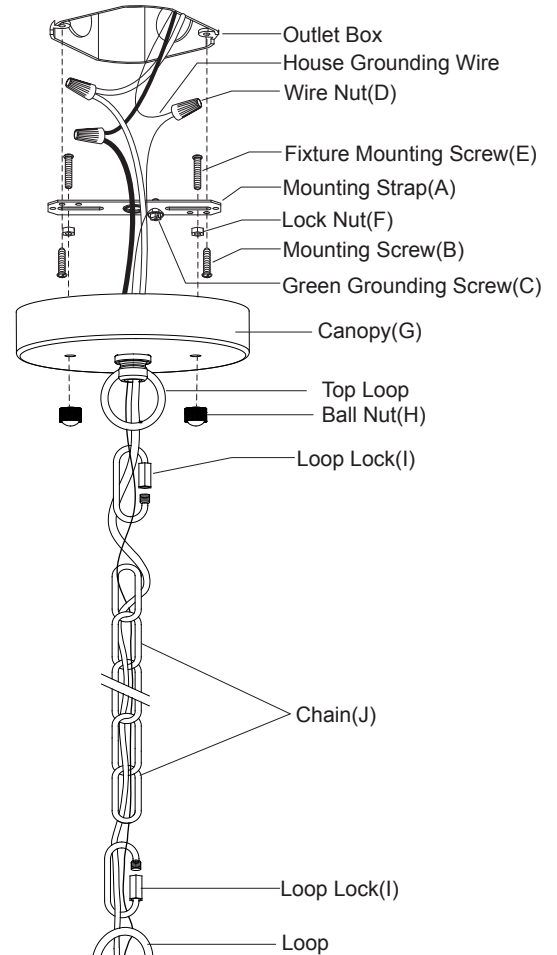
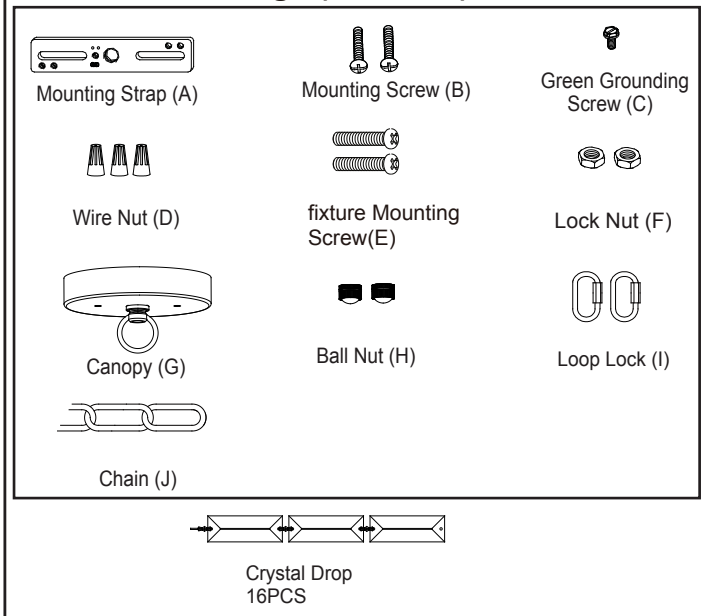

## Installation Steps

Turn off the power at fuse or circuit box

1. Thread two fixture mounting screws through the mounting strap, and then secure them with two lock nuts. Adjust the length of the fixture mounting screws if necessary.
2. Attach the mounting strap to the outlet box by using two mounting screws.
3. Install a bulb (not included). Check relamping label at socket area or packaging for maximum allowed wattage.
4. Install the crystal drops as shown in diagram.
5. Connect the chain:
  - Determine needed length of chain to achieve desired fixture height. (To remove excess chain section, use pliers to bend link open.)
  - Weave the fixture wires through the chain and canopy.
6. Connect one end of the chain to the loop using a loop lock.
7. Connect the other end of the chain to the top loop using the other loop lock.

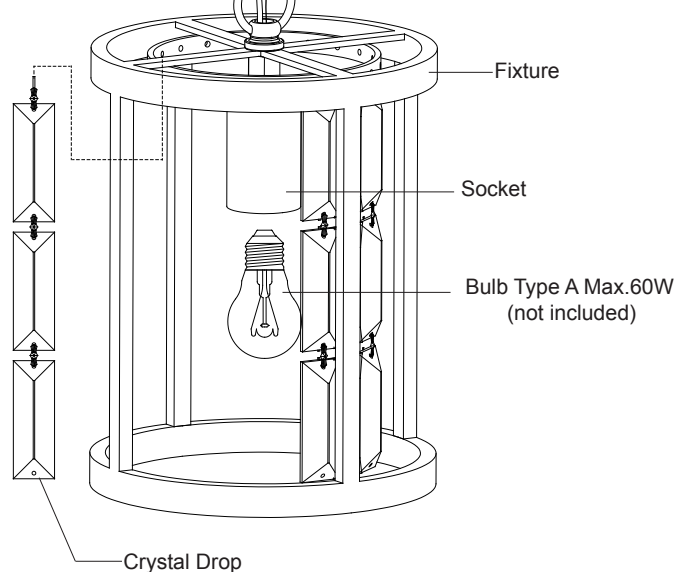









8. Thread the fixture wire and fixture grounding wire through the canopy and mounting strap.
9. Pull out the source wires from the outlet box. Make wire connections using wire nuts as follows:
  - Connect the smooth-coated wire (marked) from the fixture to the black wire from the power source.
  - Connect the ribbed-coated wire (unmarked) from the fixture to the white wire from the power source.
  - Attach the fixture grounding wire to the mounting strap with the green grounding screw, and then connect it to the house grounding wire with a wire nut.
 Carefully put the wires back into the outlet box.
10. Attach the canopy to the mounting strap, and then secure it with two ball nuts.

**Turn on the power at fuse or circuit box**

**The following parts are available for re-order if damaged or missing.**

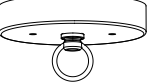
**Spare Parts List:**

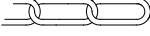
				
Mounting Strap (A)	Mounting Screw (B)	Green Grounding Screw (C)	Wire Nut (D)	fixture Mounting Screw (E)
				
Lock Nut (F)	Canopy (G)	Ball Nut (H)	Loop Lock (I)	Chain (J)

→ Assembly Kit 5430MM (1 SET)

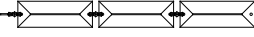
  
Crystal Drop 5088CY(1 SET)

